

**Part No:** 806-012C

**Schedule 80 PVC & CPVC**

**Elbow**

**Desc:** 1-1/4 CPVC 90 ELL SOC SCH80

**MSRP:** 29.34

**Part Code:** 090

**Weight(lbs):** 0.311

**Weight(kg):** 0.141

**Weight(gm):** 141

**Size:** 1-1/4"

**Color:** GRAY

**Material:** CPVC

**Connection** Socket x Socket

**Angle** 90°

**Type** Standard

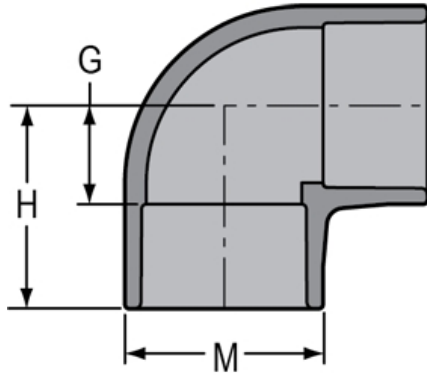

**G** = 1-1/32

**H** = 2- 9/32

**M** = 2-3/32

## Injection Molded Dimension References:

**G** = (LAYING LENGTH) intersection of center lines to bottom of socket/thread; 90° elbows, tees, crosses; ± 1/32 inch.

**H** = Intersection of center lines to face of fitting; 90° elbows tees, crosses; ± 1/32 inch.

**J** = Intersection of center lines to bottom of socket/thread; 45° elbows; ± 1/32 inch

**L** = Overall length of fittings; ± 1/16 inch.

**M** = Outside diameter of socket/thread hub; ± 1/16 inch.

**N** = Socket bottom to socket bottom; couplings; ± 1/16 inch.

**W** = Height of cap; ± 1/16 inch

## Typical Molded Dimension References

