

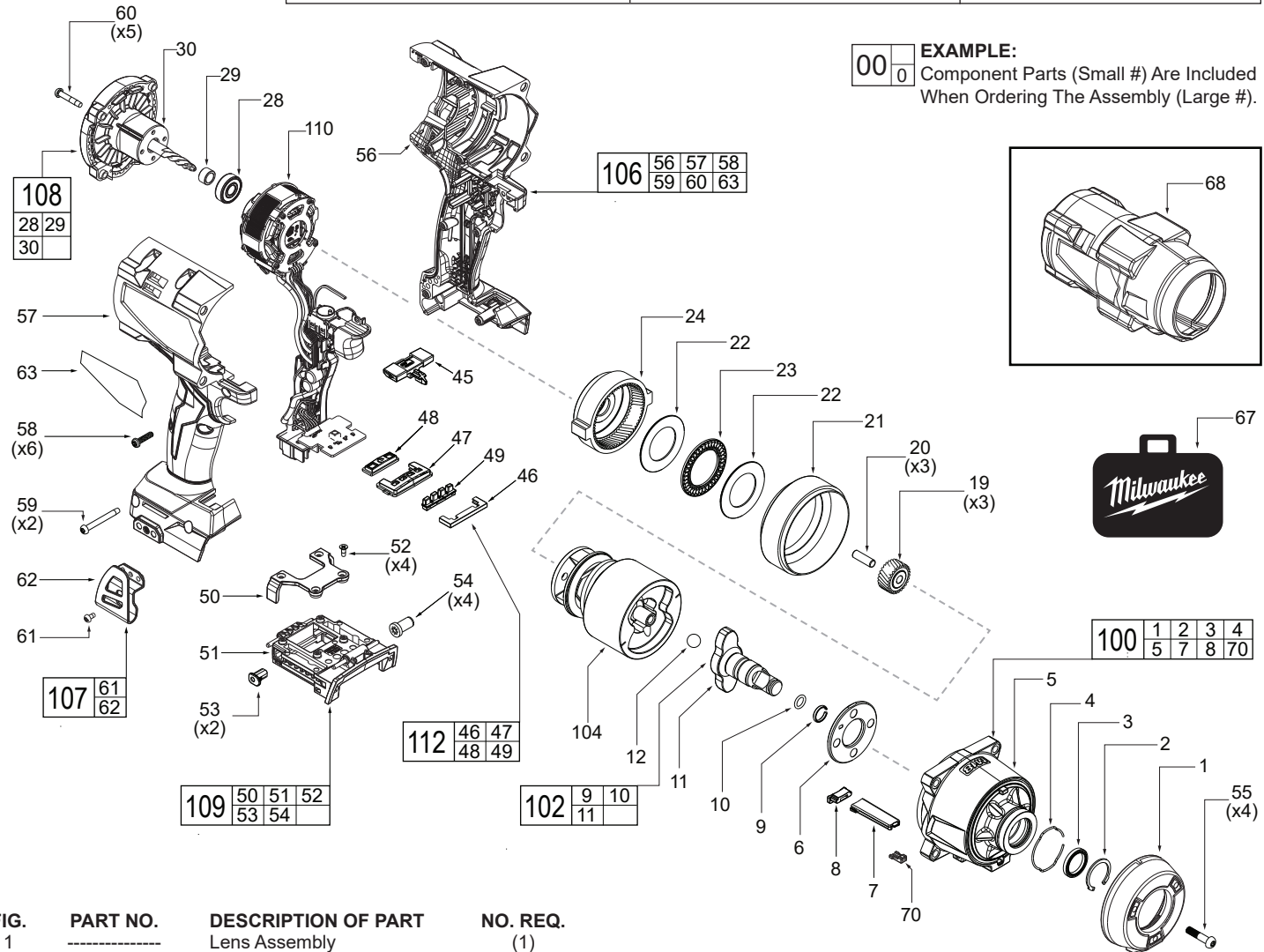

SERVICE PARTS LIST

BULLETIN NO.
54-26-2910

SPECIFY CATALOG NO. AND SERIAL NO. WHEN ORDERING PARTS		REVISED BULLETIN	DATE
M18 FUEL™ 1/2" High Torque IMPACT WRENCH w/ friction ring			Sep. 2023
CATALOG NO. 2967-20	SERIAL NO. N80A	WIRING INSTRUCTION See Page 3	



EXAMPLE:
Component Parts (Small #) Are Included
When Ordering The Assembly (Large #).

FIG.	PART NO.	DESCRIPTION OF PART	NO. REQ.
1	-----	Lens Assembly	(1)
2	44-86-0032	Inverted Retaining Ring	(1)
3	45-06-7070	Anvil Seal	(1)
4	-----	Shadowless Retaining Clip	(1)
5	-----	Gear Case	(1)
6	45-88-9125	Anvil Washer	(1)
7	-----	Shadowless Wire Boat	(1)
8	-----	Rubber Plug	(1)
9	44-90-4530	Ring, Friction\4140 Steel	(1)
10	34-40-0900	O-Ring	(1)
11	-----	1/2" FR Anvil	(1)
12	02-02-2070	Steel Ball 10.0mm	(1)
19	32-62-0705	Planet Gear	(3)
20	44-60-5430	Planet Gear Pin 6.0mm	(3)
21	46-06-7060	Rubber Seal	(1)
22	45-88-9135	Thrust Washer	(2)
23	02-50-7035	Thrust Needle Bearing	(1)
24	32-65-2875	Ring Gear	(1)
28	02-04-7165	Bearing	(1)
29	42-40-7155	Rotor Shaft Bushing	(1)
30	-----	Rotor	(1)
45	45-24-9040	Forward/Reverse Shuttle	(1)
46	-----	Speed Select Board, Rubber	(1)
47	-----	Mode Selector	(1)
48	-----	Mode Select Button	(1)
49	-----	Light Pipe, Mode Select	(1)
50	-----	Bracket	(1)
51	-----	Isolator	(1)
52	05-78-0088	M3 x 8mm Flat Hd. ST Screw	(4)

FIG.	PART NO.	DESCRIPTION OF PART	NO. REQ.
53	45-30-1060	Rubber Slug	(2)
54	45-30-1070	Rubber Bumper	(4)
55	06-81-9555	M5 x 23mm Pan Hd. Torx T-25 M Screw	(4)
56	-----	Handle Support	(1)
57	-----	Handle Cover	(1)
58	06-82-0995	M4 x 16mm Pan Hd. Torx T-20 ST Screw	(6)
59	06-82-4002	M4 x 35mm Pan Hd. Torx T-20 ST Screw	(2)
60	06-82-4001	M4 x 22mm Pan Hd. Torx T-20 ST Screw	(5)
61	-----	#6-32 Pan Hd. Torx T-15 Slot B M Screw	(1)
62	-----	Belt Hook	(1)
63	12-20-9945	Service Nameplate	(1)
67	42-55-9525	Blow Molded Case (BMC)	(1)
68	49-16-2967	Rubber Boot	(1)
70	-----	Rubber Plug	(1)
100	14-29-9045	Front Gearcase Assembly	(1)
102	42-06-5320	Anvil Assembly	(1)
104	14-30-6310	Impact System Assembly	(1)
106	14-34-7130	Handle Kit	(1)
107	42-70-0950	Belt Kit	(1)
108	16-01-6035	Rotor Assembly	(1)
109	14-50-7015	Isolator Kit	(1)
110	14-20-9345	Electronics Assembly	(1)
112	45-24-9050	Mode Selector Kit	(1)

Lubrication Notes

NOTE

Regarding parts to be lubricated:
Apply a light coating of grease to all highlighted parts shown prior to installation. Reference the key below for grease types.

 Type 'J' Grease
No. 49-08-4220





NOTE

When servicing, remove 90-95% of the existing grease prior to installing Type 'J'. Original grease may be similar in color but not compatible with the 'J'. Clean gear assemblies with a clean, dry cloth.

Torque Specifications



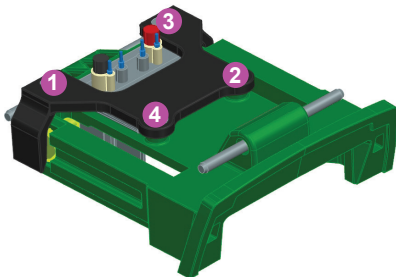

NOTE

Follow the fastening tightening procedure for screw tightening and loosening.

	52	= 05-78-0088
	55	= 06-81-9555
	58	= 06-82-0995
	59	= 06-82-4002
	60	= 06-82-4001



SCREW TORQUE SPECIFICATIONS

FIG.	PART NO.	DESCRIPTION OF FASTENER	WHERE USED	SEAT TORQUE		
				(kgf-cm)	(lb-in)	
	52	05-78-0088	M3 x 8mm Flat Head ST Screw	Isolator	4.2 ± 0.5	3.6 ± 0.4
	55	06-81-9555	M5 x 23mm Pan Head Torx T-25 M Screw	Gear Case	75 ± 8	65 ± 7
	58	06-82-0995	M4 x 16mm Pan Head Torx T-20 ST Screw	Handles and Top Housing	16 ± 2	14 ± 1.7
	59	06-82-4002	M4 x 35mm Pan Head Torx T-20 ST Screw	Top Housing	18 ± 2	16 ± 1.7
	60	06-82-4001	M4 x 22mm Pan Head Torx T-20 ST Screw	Rotor Assembly	16 ± 2	14 ± 1.7

Wiring

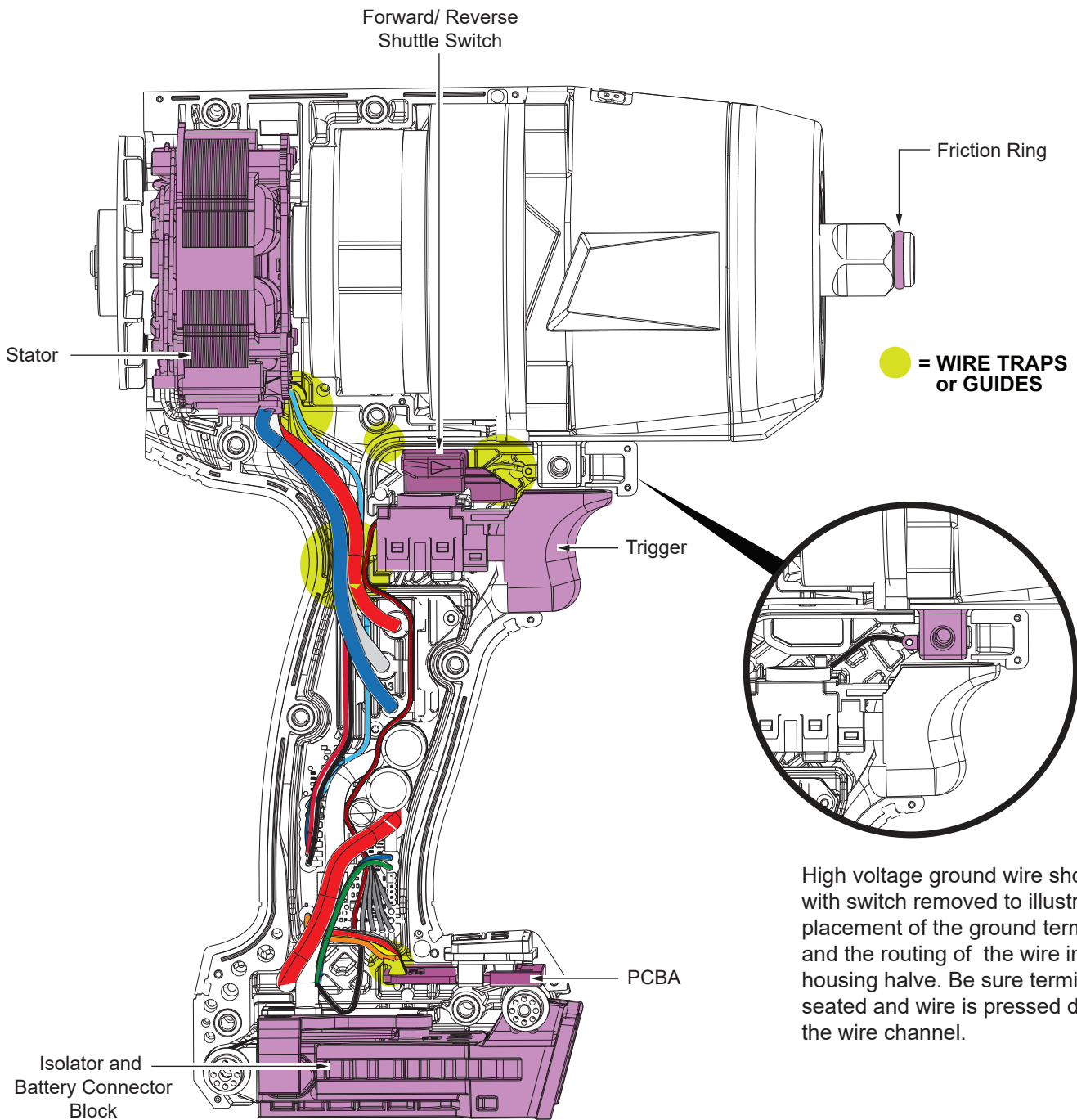

Be sure that all wires of the electronics assembly are routed as shown, being careful to push down completely into wire traps. Be sure that the trigger switch, PCBA, battery connector block, stator and shuttle switch are fully seated prior to installing the handle cover.