

HIGH EFFICIENCY VERTICAL MULTISTAGE CENTRIFUGAL PUMP

Series: **HMV5-110-203**
2 HP



* Representative image

TECHNICAL DATA								
MODEL	PART No.	HP	RPM	V	MAX. AMPS	MAX. TEMP. (°F)	MAX. Q (gpm)	MAX. H (ft)
HMV5-60-103	70120101A	1	3500	230/460	2.9/1.5	248	8.5	245
HMV5-80-153	70120101B	1.5	3500	230/460	4.2/2.1	248	8.5	328
HMV5-100-203	70120101H	2	3500	230/460	5.5/2.7	248	8.5	410
HMV5-110-203	70120101C	2	3500	230/460	5.5/2.7	248	8.5	450
HMV5-130-303	70120101J	3	3500	230/460	7.9/3.9	248	8.5	530
HMV5-140-303	70120101L	3	3500	230/460	7.9/3.9	248	8.5	574
HMV5-160-303	70120101D	3	3500	230/460	7.9/3.9	248	8.5	656
HMV5-170-403	70120101N	4	3500	230/460	10.3/5.1	248	8.5	695
HMV5-190-403	70120101P	4	3500	230/460	10.3/5.1	248	8.5	777
HMV5-210-403	70120101R	4	3500	230/460	10.3/5.1	248	8.5	860
HMV5-230-403	70120101E	4	3500	230/460	10.3/5.1	248	8.5	940

ITEM	NAME	MATERIAL	AISI/ASTM
1	Motor	-	-
2	Bracket	Ductile cast iron	ASTM A536 65-45-12
3	Seal base	Stainless steel	AISI 304
4	Mechanical seal	SiC/Carbon	-
5	Top diffuser	Stainless steel	AISI 304
6	Diffuser	Stainless steel	AISI 304
7	Support diffuser	Stainless steel	AISI 304
8	Coupling	Ductile cast iron	ASTM A536 65-45-12
9	Impeller	Stainless steel	AISI 304
10	Cylinder	Stainless steel	AISI 304
11	Shaft	Stainless steel	AISI 304
12	Bearing	Tungsten carbide	-
13	Inducer	Stainless steel	AISI304
14	Inlet & outlet chamber	Stainless steel	AISI 304
15	Base	Cast iron	ASTM 25B

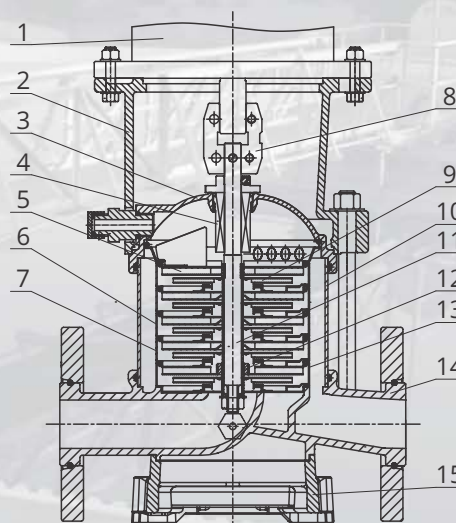

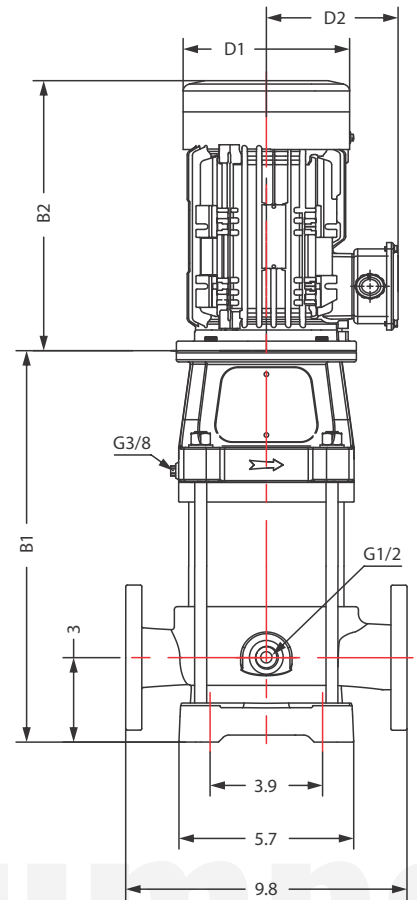
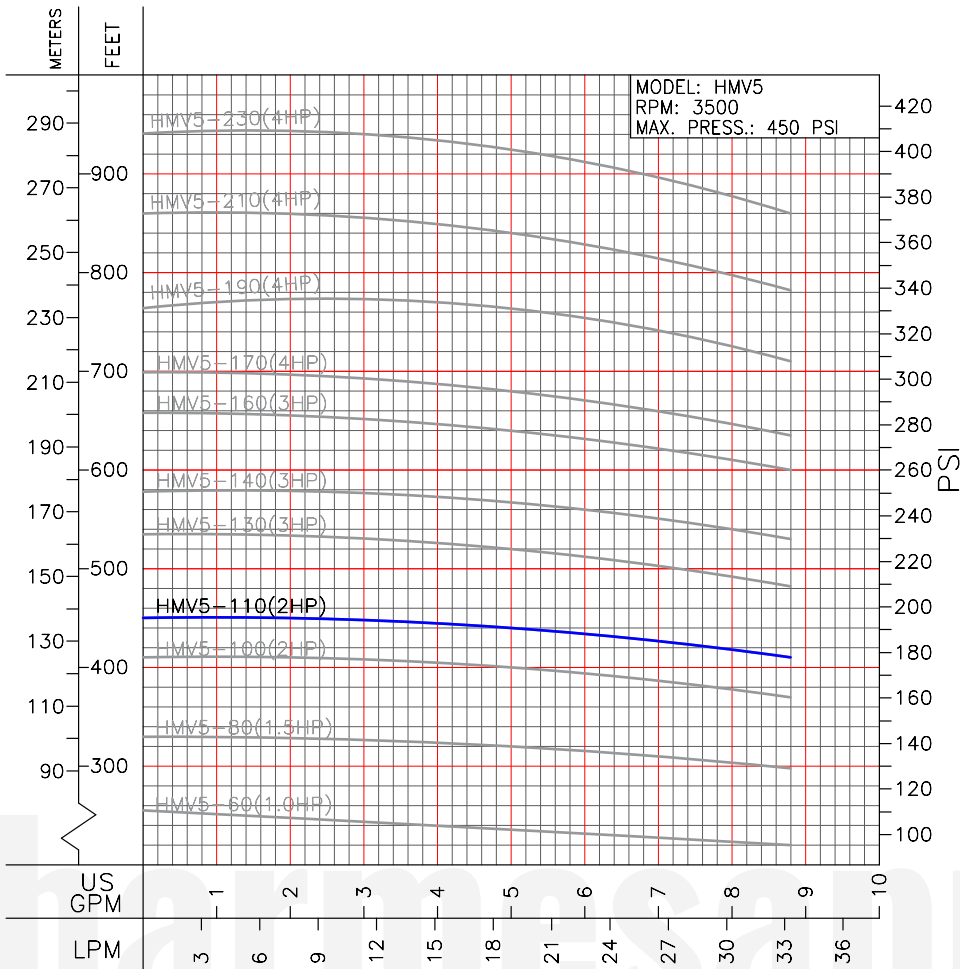

1 1/4" / ANSI / CLASS 300

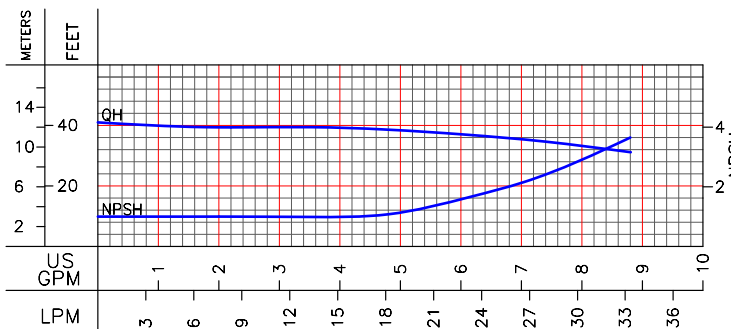
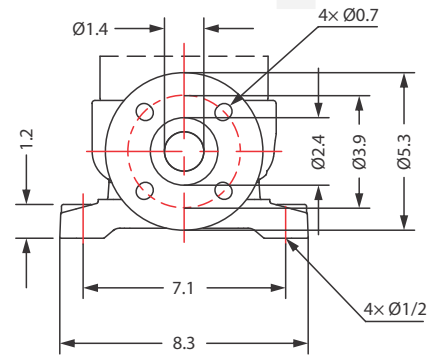
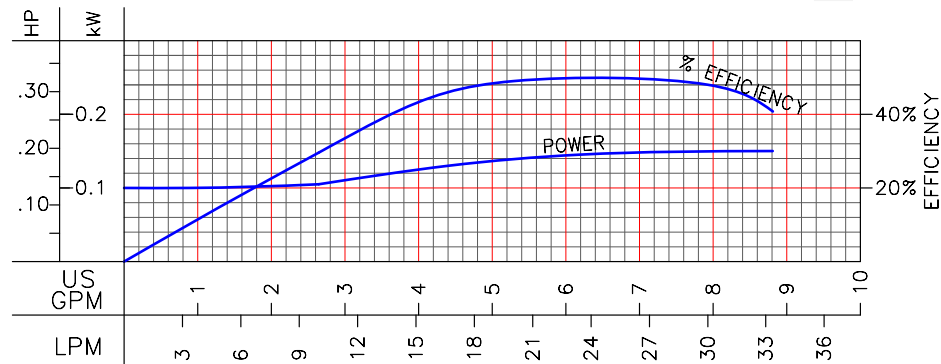

MODEL	HP	STAGES	SIZE (in)				WEIGHT (lb)	
			B1	B2	B1+B2	D1		D2
HMV5-60-103	1	6	14	11	25	7	6	66
HMV5-80-153	1.5	8	15	11	26	7	6	75
HMV5-100-203	2	10	17	14	31	7	6	90
HMV5-110-203	2	11	17	14	31	7	6	90
HMV5-130-303	3	13	19	14	33	7	6	101
HMV5-140-303	3	14	20	14	33	7	6	104
HMV5-160-303	3	16	21	14	35	7	6	108
HMV5-170-403	4	17	22	16	38	8	6	121
HMV5-190-403	4	19	24	16	40	8	6	123
HMV5-210-403	4	21	25	16	41	8	6	128
HMV5-230-403	4	23	26	16	43	8	6	132